

# BASEMENT INSULATION SYSTEMS

## THE PROBLEM

Meeting **Energy Star** levels of performance is one of the criteria for constructing homes to **Building America** levels of performance – levels defined by the **Building Science Consortium** and others. Homes constructed with basements require some degree of basement insulation to meet **Energy Star**. As a result all **Building America** homes with basements constructed by the **Building Science Consortium** have basement insulation.

In any event, heat loss from basements accounts for such a significant portion of the energy loss from a home that it is clear that a home with a basement must have basement insulation to be called “**energy efficient**.” Additionally, in many jurisdictions, basement insulation is a building code requirement.

Finally, most homeowners with homes with basements finish the basement area for additional living space. When they do, they typically insulate the perimeter walls. Homes with basements often end up with basement walls that are finished and insulated.

There are only three ways to insulate a basement wall: on the interior, on the exterior or in the middle (**Figure 1**). Of the three, the most common approach has been to insulate basements internally. The reasons for this have been due almost strictly to cost.

Externally insulated basements have a major cost factor associated with protecting the exposed above grade portion of the insulation assembly and shifting the house structure outward to compensate for the thickness of the exterior basement insulation (**Figure 2**). Most protection systems involve some form of rendering (stucco, synthetic stucco, cement parge

**Figure 1**

Basement insulation locations

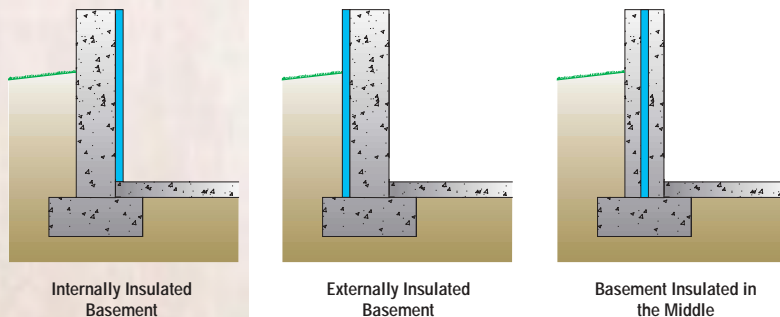

coats, etc) that have proven to be not durable (the “weed-whacker” problem). Furthermore, protecting the exposed insulation system during the construction process until it gets covered has also been a major challenge – so much so that most builders who have done it once, do not want to do it again.

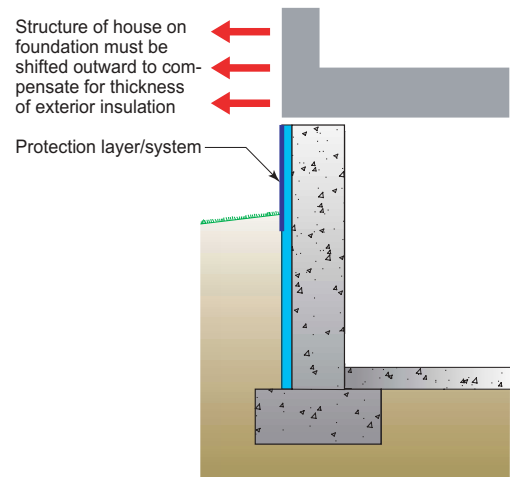

**Figure 2**

Costs associated with exterior basement insulation

- Protection layer/system for exposed insulation above grade wall
- Change in practice requiring exterior shift of house structure
- Protecting exposed insulation during construction process until protection layer/system can be installed

Internally insulated basements are often coupled with interior basement finishing and therefore offer a “**higher perceived value**” to the homebuyer. “My basement is almost finished – I just have to add drywall...”

For these reasons most basements are insulated internally.

All **Building America** homes constructed by the **Building Science Consortium** were initially constructed with interior basement insulation. The approaches used early in the program were interior stud wall framing insulated with fiberglass batts and “**blanket**” insulation (**Figure 3**). These two approaches

are the most common approaches to basement insulation used by the home building industry in general.

Photographs 1, 2, 3 and 4 illustrate the two approaches. Note the installation of an interior vapor barrier in Photograph 2, and the impermeable interior surfaces in Photograph 3 and Photograph 4.

**Figure 3**  
Interior insulation approaches

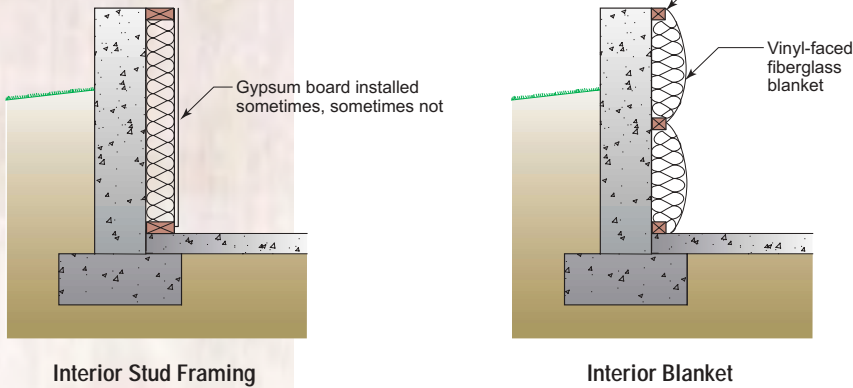

Interior Stud Framing

Interior Blanket

The experience by the **Building Science Consortium** with these two approaches has been bad. The **Building Science Consortium** has concluded that these two approaches are unsuitable for use by the home building industry due to serious problems associated with mold, decay and odors. This is consistent with reports from Canada where basements are insulated in a similar manner (Fugler, 2002) and from other researchers in the United States, notably in Minnesota (Ellringer, 2002). Continued use of these approaches by the home building industry will likely lead to a disaster of unprecedented proportions and may result in the construction of energy efficient homes being set back a generation.



**Photograph 1**  
Interior stud framing located at basement perimeter

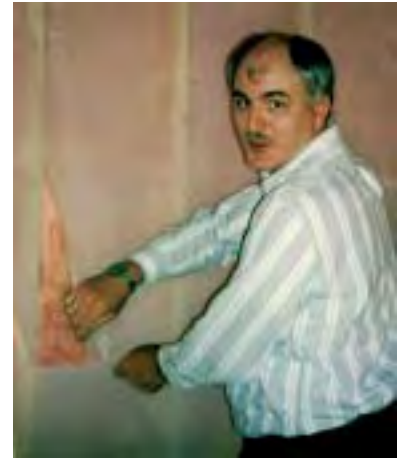

**Photograph 2**  
Interior basement stud framing insulated with fiberglass batts and covered with a polyethylene vapor barrier



**Photograph 3**  
Blanket insulation with impermeable vinyl interior surface



**Photograph 4**  
Blanket insulation with impermeable aluminum foil interior surface

## THE PHYSICS OF THE PROBLEM

The problem associated with interior stud wall framing insulated with fiberglass batts and “blanket” insulation is due to the accumulation of moisture within the insulated frame wall located on the interior of the basement foundation or within the blanket insulation located on the interior of the basement foundation wall. This moisture leads to mold, decay and odors.

Moisture enters the insulated assemblies due to five wetting mechanisms:

- Moisture of Construction (**Figure 4**)
- Air Leakage (**Figure 5**)
- Capillary Rise (**Figure 6**)
- Diffusion (**Figure 7**)
- Ground Water Leakage (**Figure 8**)

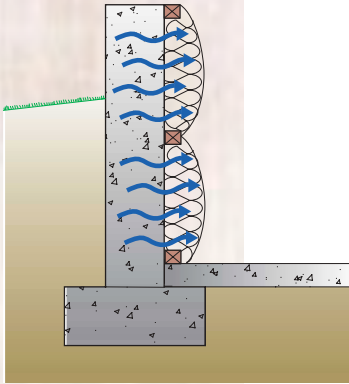

**Figure 4**

Moisture of construction

- Thousands of pounds of water are contained in freshly placed concrete in basement foundation walls; drying in uninsulated exposed walls takes many months, longer in walls with impermeable insulation systems

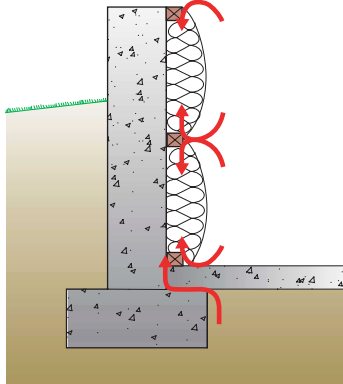

**Figure 5**

Air leakage from interior and from exterior under slab

- This is the “summer” problem where interior moisture laden air leaks into insulation systems and contacts cold concrete or masonry
- Can also be a winter problem, but is not usually common due to typically lower winter interior relative humidities - except in severe cold climates (greater than 8,000 heating degree days)

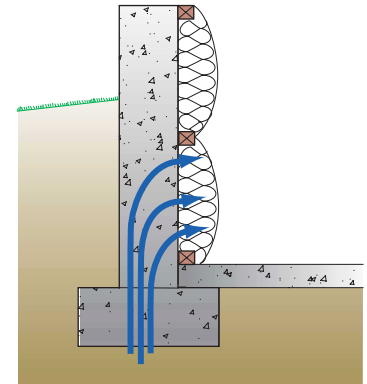

**Figure 6**

Capillary rise through footing

- This was rarely a problem until foundation walls became insulated on the interior with impermeable layers

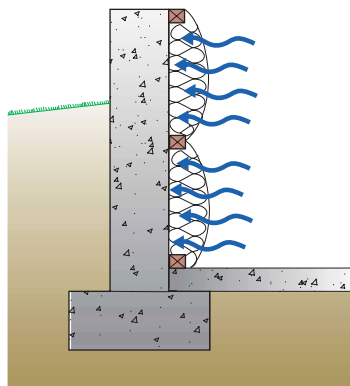

**Figure 7**

Diffusion from interior

- This is also a “summer” problem; occasionally a “winter” problem

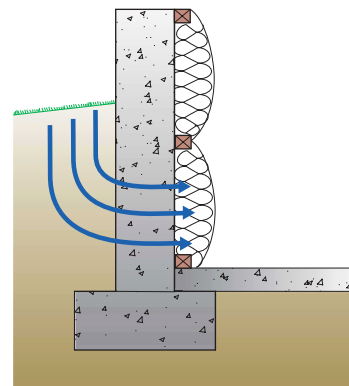

**Figure 8**

Groundwater leakage through foundation

- Major problem with water sensitive interior insulation and finishing systems

The internally insulated frame wall and blanket insulation approaches are unable to adequately handle these wetting mechanisms singularly or in combination. These two approaches are constructed with vapor barriers or with vapor retarders and are incapable of allowing foundation walls to dry to the interior. This is an issue with moisture of construction, capillary rise and ground water leakage. Simply leaving off interior vapor barriers and vapor retarders will not work due to the issues associated with interior vapor diffusion.

Additionally, these two methods are incapable of being constructed in an airtight manner using typical production trades and materials and therefore are unable to address the air leakage wetting mechanism.

Finally, these two methods are constructed with moisture sensitive materials and therefore are unable to tolerate even minor groundwater leakage, therefore requiring builders to be **"perfect"** in controlling groundwater – an impossible requirement.

The problems with these two common approaches to interior basement insulation manifest themselves in mold, decay and odors (**Photographs 5, 6 and 7**).

The problems experienced by the **Building Science Consortium** with **Building America** homes constructed with internally insulated basements and the reported similar problems by others in the building industry led to a major effort to develop insulation approaches to basement construction that did not result in mold, decay and odors. The effort was not limited to the construction of new homes, but also focused on the insulation retrofit of existing basements. The nature of the problem for existing homes was deemed to be similar to the problem associated with the construction of new homes.

The experience acquired by the **Building Science Consortium** has been reflected in changes that have been made to the *Builder's Guide Cold Climate* (Lstiburek, 2001) as well as those for *Builder's Guide Hot-Dry & Mixed-Dry Climate* (Lstiburek, 2000) and *Builder's Guide Mixed-Humid Climate* (Lstiburek, 2001). All recommended basement interior insulation strategies involve placement of a layer of rigid foam insulation against the foundation wall. The moisture sensitive interior wood framing and paper faced gypsum board are no longer in contact with the major moisture source – the concrete or masonry foundation wall.



**Photograph 5**  
Frame wall with interior vapor barrier resulting in mold, decay and odors



**Photograph 6**  
Water trapped behind polyethylene installed directly against foundation wall



**Photograph 7**  
Mold with blanket insulation

## BACKGROUND

Heat loss through uninsulated basement walls is a significant energy penalty in heating climates. In addition cool basement walls are undesirable when basements are finished or used for recreation. Insulating basement walls is logical and desirable as long as the walls remain free of moisture problems.

Unfortunately, safely insulating basement walls requires consideration of many factors in addition to reducing thermal conductivity across the foundation wall. Moisture dynamics must be considered in detail before insulating a basement wall. Materials used to insulate a basement wall must be selected based on their ability to control the flow of moisture and air as well as heat. Selecting the wrong type of insulation or placing it in the wrong wall assembly often leads to moisture accumulation with subsequent material deterioration and growth of mold.

Almost all basement walls can be safely insulated if **moisture flow** and **airflow** are also controlled. Accomplishing this can be difficult and frequently is expensive. In many older homes and some newer homes basements cannot be insulated safely and inexpensively. The cost of properly insulating a basement while controlling moisture should be compared with the cost of constructing additional quality living space above grade. A damp or wet basement that is improperly insulated will lead to deterioration of the building envelope and promote conditions that worsen indoor air quality.

## HEAT FLOW IN BASEMENT WALLS

Heat loss from an uninsulated basement can account for up to one third of the heating cost in an average home (Timusk, 1981). This varies depending on many factors, such as the air tightness of the building envelope, the amount of insulation in the house and the height of the above grade portion of the basement wall. Since the above grade portion of the basement wall is exposed to colder temperatures than the below grade portion of the wall it loses heat at a much greater rate than the below grade portion of the wall. For a basement in a 4,000 heating degree-day location, insulating the upper half of the basement wall with R-5 insulation reduces the heat loss from the basement by approximately 50 percent. Full height insulation (R-5) in the same location reduces heat loss from the basement by approximately 70 percent. Insulating the exterior wall to grade and the upper half of the interior wall results in approximately 10 percent more heat loss than full height insulation on either the interior or the exterior. These values are derived from Timusk's work (1981). These calculations apply to concrete walls or block walls with filled cores where no

air convection can occur within the wall itself. The band joist area is also not considered in these calculations.

The energy savings that can be achieved by insulating a heated basement are substantial and justify the cost in many situations as long as installing the insulation does not exacerbate existing moisture problems.

## THE MOISTURE DYNAMICS OF BASEMENT WALLS

A basement wall will remain dry only if it is built to handle all the different ways in which water can move into and through basement walls. Since walls will at times get wet in spite of good design and construction, basement walls must also be able to dry. Drying typically means towards the interior. Rarely, are foundation assemblies able to dry towards the exterior – except above grade.

The actual moisture content of a material or wall assembly is dependent on the balance between wetting and drying. If wetting exceeds drying, moisture accumulation occurs. If accumulation increases to a critical moisture content, susceptible materials will begin to support mold growth and decay.

Basement walls can be wetted by liquid water (bulk flow and capillary suction) and water vapor. Effective interior drainage can safely drain liquid water from the wall assembly. However, once materials become wet, they can typically dry only by the removal of water vapor either by evaporation or diffusion. Evaporation requires energy but insulation decreases the flow of energy. Insulated walls cannot dry as easily as uninsulated walls. Liquid water can enter materials by bulk flow or by capillary suction. Poorly graded land adjacent to buildings and non-functioning or absent gutters and downspouts may allow rain to flow down the foundation wall where it can enter cracks. This water may also temporarily raise the water table so that

water enters the foundation wall because of increased hydrostatic pressure. Proper diversion of rainwater and effective foundation drainage can prevent the entry of liquid water by these processes.

Water can enter foundation walls by **capillary suction** when damp soil contacts the foundation wall. Clay soils can transfer large volumes of moisture through a basement wall by capillary suction. Installation of a capillary break between the soil and the foundation wall will prevent capillary wetting of the wall. Rigid insulation, free draining back fill, drainage boards, damp-proofing and water proofing are effective capillary breaks. If the foundation footer rests on damp soil, large quantities of water can be drawn into the wall by capillary suction. A capillary break can be installed or applied to the top of the footer at the time of construction, but is almost impossible to accomplish once the wall is built.

**Water vapor** can move by two different mechanisms: **diffusion** and **air transport**. Diffusion involves the movement of individual molecules of water in the gas state due to the kinetic energy of the molecules. Diffusion is dependent on the temperature of the water molecules as well as the concentration of the molecules. Water vapor moves from areas of higher concentration to areas of lower concentration and from areas of higher temperature to areas of lower temperature. The rate at which water vapor moves through materials is referred to as "**permeability**". Individual water molecules can move easily through permeable materials even if the materials do not permit airflow through them. Other materials are said to be semi-permeable to water vapor because they permit the passage of water molecules at a much slower rate. Materials that allow very little water vapor to pass through them are classified as impermeable.

**Air transport** of water vapor requires an air pressure difference as well as a pathway or opening between the areas of differing air pressure. Air movement through solid foundation walls of concrete or filled cement block can only occur through cracks or voids, not through the material itself. Stacked stone or hollow core block foundation walls may permit the passage of large volumes of moisture-laden air.

Diffusion from the exterior can be controlled by damp-proofing or water proofing. It is more difficult to stop the movement of moisture-laden air through leaky stone or masonry basement walls. Special care must be taken when attempting to insulate this type of wall. The addition of insulation may inhibit drying of the wall thereby allowing more moisture to wet the wood sill and band joists above the foundation. Interior insulation will

also cause the sill plate and band joists to be cooler and at greater risk for wetting from condensation.

Below grade walls exist in an environment that differs considerably from the above grade environment. Moisture in the soil below a depth of 3 feet is almost always greater than the moisture in the air interior to the basement wall. Therefore water vapor drive through the lower part of the basement wall will be from the exterior to the interior. The exterior environment for the upper part of the basement wall varies greatly with climate and time throughout the year. During the summer months the water vapor drive will be from the exterior to the interior while during the cold winter months the vapor drive will be from the interior to the exterior. These facts must be considered when designing an insulated basement wall assembly.

## EFFECTS OF INSULATING BASEMENT WALLS

From a moisture and thermal perspective, basement walls with insulation on the exterior perform better than basement walls with insulation on the interior. Walls with exterior insulation are "**warm**" and can dry to the interior. Since the walls are warm there is little risk of condensation of interior moisture. No vapor barrier should be installed on the interior side of externally insulated basement walls. In fact a vapor barrier on the interior would prevent the walls from drying should they ever get wet. However, exterior insulation is rarely installed because of perceived difficulties protecting it from damage during backfilling. In addition, protecting the above grade portion of the exterior insulation in an effective and attractive but inexpensive way remains elusive. This was true in 1981 when Timusk wrote his *Insulation Retrofit of Masonry Basements* and remains true today.

When exterior insulation is installed on basement walls it is often limited to the below grade portion of the walls. The above grade portions of the walls are then either left uninsulated or insulated on the interior. Heat loss through uninsulated above grade basement walls is quite significant accounting for up to 30 percent of the total heat loss from the basement (Timusk, 1981). Insulating the top portions of the walls on the interior is thermally less efficient than insulating the entire wall on the exterior and must accommodate the changing water vapor drive during the course of the year.

Insulating only on the interior side of basement walls presents problems because of ground water and the alternating direction of the vapor drive discussed above. The fact that ground temperature at various depths frequently is much colder than either exterior or interior air temperatures means that condensation can occur on the interior surface of the foundation wall. The interior basement insulation and the finished wall assembly are subjected to potentially significant moisture loads from vapor driven from both the exterior and the interior at different times of the year.

While the building industry in the United States has become preoccupied in the past decade with vapor diffusion and vapor barriers in building assemblies, the problem of air-transported water vapor is often ignored. This is unfortunate because air-transported moisture is generally much more of a problem than is the diffusion of water vapor. Airflow occurs when there is a pathway and a pressure difference between two areas or parts of a building or building assembly. More moisture will move through a small opening across which a small difference in pressure is maintained than will move through a large area of the building envelope by diffusion. Air transported moisture also tends to be concentrated while diffusion is a more uniform or distributed process. Consequently air transported moisture can quickly lead to deterioration in moisture sensitive materials.

The entire consideration of water vapor has been complicated and confused by the fact that some materials can block the flow of air (**an air barrier**) as well as the flow of vapor (**a vapor barrier**). Some research in basement insulation systems has attributed moisture accumulation to vapor diffusion when airflow was not controlled. An effective air barrier is required in basement walls. However, vapor barriers are typically not needed – particularly on the interior of basement assemblies. In limited applications such as where a vapor barrier membrane is installed against a wet wall to provide drainage can a vapor barrier be effective in reducing the inward movement of moisture. However, this membrane must be

protected from condensation on the interior side by placement of insulation and an air barrier.

The almost indiscriminate use of vapor barriers (polyethylene or vinyl wall coverings) over the past decade has caused many building failures and facilitated the growth of mold in many buildings. The permeability of materials must be considered before placing them in a particular location within a wall assembly. Otherwise water vapor may become trapped within a wall assembly where it can condense when the temperature is low enough.

Any interior basement insulation strategy must successfully handle both the internal and external moisture loads. One proposed solution to this dilemma is to install a vapor barrier on both sides of the interior insulation system. The barrier against the foundation wall is often called a moisture barrier. The main problem with a double vapor barrier wall is that it cannot dry to either the inside or the outside should it ever get wet. In addition, it requires a perfect air barrier on the interior to prevent warm interior air from contacting and condensing on the cold foundation wall where it may be trapped. This type of construction should be avoided.

## LITERATURE REVIEW

The literature on basement insulation systems can be divided into two main types: controlled studies and reviews with recommendations on how to insulate basements using methods that have not been systematically evaluated. Multiple studies (Kesik et al, 2001, Goldberg, 1999) have demonstrated the effectiveness of exterior basement insulation over a 1 – 2 year period.

Research on interior basement insulation systems has been much more limited with several studies focusing only on the ability of the wall assembly to dry after wetting. All

of the studies on the installation of insulation on the interior of basement walls that we reviewed are limited in their usefulness because of design flaws (absence of an interior air barrier or the presence of an interior vapor barrier or both) or limited wall assembly types that were included.

In 1981 John Timusk of the University of Toronto published a monograph entitled *Insulation Retrofit of Masonry Basements*. If the information in his publication had been widely disseminated we might have fewer problems with insulated basements. Timusk looked at the moisture flow through different types of basement walls and how different insulation strategies affected that moisture flow. He also looked at the effect of various insulation methods on the heat loss from basement walls. Timusk's recommendations are quite similar to our recommendations below. The major change in the past 20 years is the realization that a vapor barrier (usually polyethylene) on the interior side of the basement wall assembly inhibits drying of the wall more than it prevents wetting of the wall.

Many of the ideas developed by Timusk in his 1981 paper were incorporated in the CMHC publication, *Investigating, Diagnosing and Treating Your Damp Basement*, released in 1992. Although this publication did not specifically address insulating a basement, it addresses the moisture problems that would have to be dealt with before installing the insulation.

Forest and Ackerman (1999) conducted a series of experiments for CMHC to determine "**Basement Walls that Dry.**" Ten walls of differing construction and materials were subjected to a measured leak and were then monitored for drying over several months. Unfortunately all but one wall assembly had an interior polyethylene vapor barrier that prevented any significant drying to the interior. Of these walls the one that dried the fastest was the one that did not have a moisture barrier against the foundation wall allowing the wall to dry to the exterior. Unfortunately this design would also allow the wall to become wet from the exterior likely causing condensation on the interior vapor barrier.

Goldberg and Huelman (2000) performed a series of experiments on basement insulation systems at the Cloquet Residential Research Facility that are extensively discussed on a University of Minnesota website. One study was limited to testing fiberglass batt insulation, both unfaced and Kraft faced, with various combinations of wall side and interior vapor barriers. Unfortunately they did not install an air barrier when using Kraft faced fiberglass batts so that the contribution of moisture deposition from diffusion through the Kraft facing cannot be separated moisture deposition due to airflow. Their

work clearly showed that placing batt insulation in the rim joist area with or without an interior vapor barrier results in condensation within the rim joist area. Insulating the rim joist area on the exterior is preferable; foil-faced polyisocyanurate on the interior is a retrofit option. Exterior insulating foam sheathing raises the temperature of the band joist area greatly reducing the wetting that occurs due to condensation.

Goldberg and Huelman (2000) make an important observation that many superficially dry walls will not remain dry when they are insulated. Many walls are dry because of "**their ability to continuously evaporate soil-sourced liquid water to the inside.**" Interior insulation strategies for basement walls will vary depending upon the amount of water moving through the foundation walls and the degree to which interior moisture will be controlled.

Cheple and Huelman (2001) reviewed the literature on basement moisture and insulation in their paper, *Why We Need to Know More About Basement Moisture* that they presented at the Buildings VIII conference. They correctly point out that in spite of the wide spread use of interior basement insulation, there has been very little research on this practice. They go on to describe a number of approaches to insulating basements and assign risk levels for each approach. Unfortunately, many of their approaches involve an interior vapor barrier of polyethylene. Basement wall assemblies with an interior vapor barrier can never dry if they become wet. The wide spread use of a double vapor barrier basement wall in Minnesota has resulted in many failures in some cases within one year of construction (Ellringer, 2002.)

An analysis of various strategies for internally insulating basement walls was performed at the University of Waterloo (Jeong, 2001). Walls with a combination of

extruded polystyrene and cavity batt insulation, with and without a vapor barrier, covered by gypsum board were compared with walls having only a thicker layer of extruded polystyrene and an empty frame wall covered with gypsum board. The walls with an interior vapor barrier did not get wet from the interior during the winter but they did trap moisture during the summer when moisture is moving inward. Without the vapor barrier, the fiberglass batts would remain dry if interior humidity is not excessive during the summer. Such low interior levels of relative humidity during summer conditions typically can only be achieved with active dehumidification provided by air conditioning or a dehumidifier.

Walls with 3.5 inches of extruded polystyrene (XPS) and no vapor barrier performed the best in this analysis. However, walls with 0.75 inches of extruded polystyrene and 3.5 inches of fiberglass batt insulation in the cavity would perform well as long as interior humidity was controlled below 50 percent during the summer. Increasing the extruded polystyrene to 1.0 or 1.5 inches would improve performance even with higher interior relative humidity during the summer months. This part of the analysis assumed that the concrete wall had a relative humidity of 100 percent at the exterior temperature. Since these studies were for a climate location similar to Minnesota, the thickness of rigid insulation (R-value) could be proportionately reduced in milder climates.

## REQUIREMENTS FOR INTERIOR BASEMENT INSULATING SYSTEMS

Any interior basement insulating wall system must have the following properties:

- It must be able to dry to the interior should it become wet since the below grade portion of the wall will not be able to dry to the exterior during any time of the year. This precludes an interior polyethylene vapor barrier or any impermeable interior wall finishes such as vinyl wall coverings or oil/alkyd/epoxy paint systems.
- The wall assembly must prevent any significant volume of interior air from reaching the cool foundation wall. Thus it must have an effective interior air barrier or a method of elevating the temperature of potential condensing surfaces (such as rigid insulation installed directly on the interior of concrete or masonry surfaces).
- Materials in contact with the foundation wall and the concrete slab must be moisture tolerant; that is the materials should not support mold growth or deteriorate if they become wet. However, moisture tolerant materials are not necessarily capillary resistant. That is, some materials may tolerate being wet without blocking the passage of liquid water through the materials. A capillary break must be placed between these materials and moisture sensitive materials.

## INTERIOR BASEMENT INSULATION STRATEGIES- NEW CONSTRUCTION

Exterior rigid insulation is the preferred method for insulating a basement wall during new construction. Damp-proofing and an effective drainage system are minimum requirements for any basement wall unless dry soil conditions and design permit a warm wall that can dry to the exterior. Damp-proofing inhibits wetting of the wall by the capillary action of water and retards the diffusion of water vapor from the exterior.

Many researchers recommend water proofing as superior to damp-proofing for controlling moisture in basement walls. Water proofing coatings are more impermeable to water vapor than damp-proofing and they can also resist higher levels of hydrostatic pressure at least in the short term. The flexibility of many water proofing coatings is offered as proof that they will bridge cracks that occur in basement walls and keep water out of the basement. However, there is less information about how water proofing coatings will perform when the cracks occur after the coatings have dried. The warranty that is provided by water proofing companies is also offered as proof of their effectiveness. However, one major water proofing company's warranty is void if a crack larger than  $\frac{1}{16}$ -inch occurs in the foundation wall. In addition, effective perimeter drainage, gutters and downspouts are required for maintaining the warranty. If proper foundation drainage and site management of water are accomplished, how much more effective is water proofing than damp-proofing? Is it worth the additional cost? We are not aware of any studies to support the additional cost of water proofing coatings when a foundation wall is properly drained.

Drainage of the foundation wall can be accomplished with granular backfill (sand, gravel), draining insulation board or plastic drainage boards that provide drainage spaces. Water that drains down the foundation wall must then be drained away either to daylight or to a sump pit from which the water is pumped away from the foundation (Figure 9).

Although exterior insulation is recommended for new construction (Figure 10), interior basement insulation can be installed if certain guidelines are followed. The internally insulated foundation wall will be cold and therefore the below grade portion of the wall can only dry to the interior. For this reason it cannot be completely covered with an impermeable sheathing.

The **Building Science Consortium** has developed two different basement insulation strategies for standard poured-in-place concrete and masonry walls. One method can be left exposed while the other requires covering with gypsum board or another thermal barrier. A third method uses pre-cast concrete walls that have some insulation built into the walls.

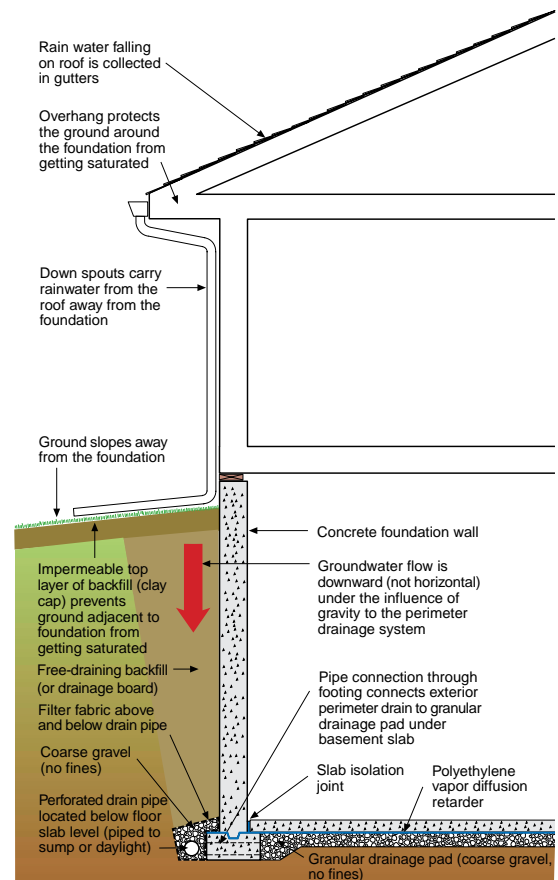

**Figure 9**  
Below grade groundwater management

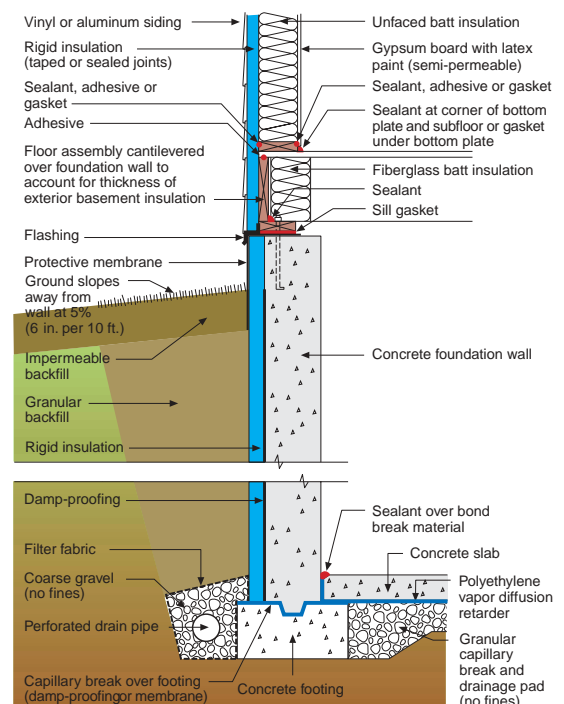

**Figure 10**  
Exterior basement insulation

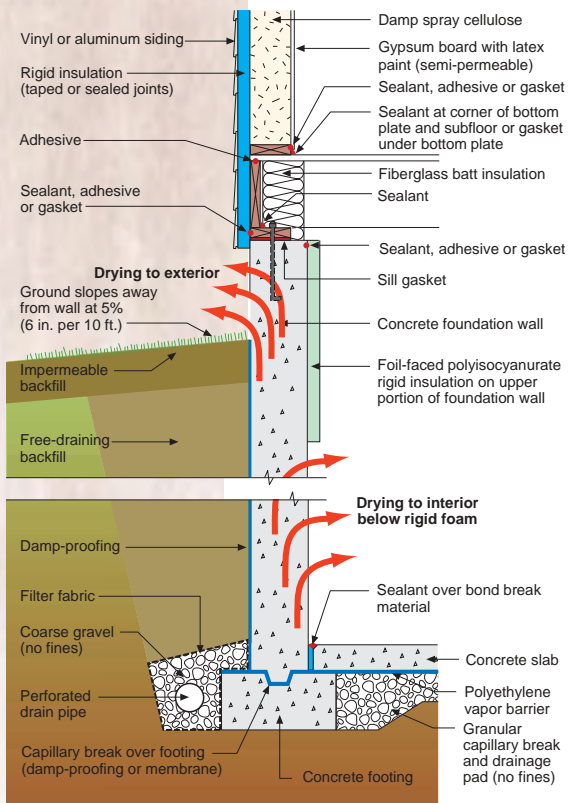

**Figure 11**

Unfinished basement with half-height insulation

- Lower portion of wall dries to the interior
- Upper portion of wall dries to the exterior

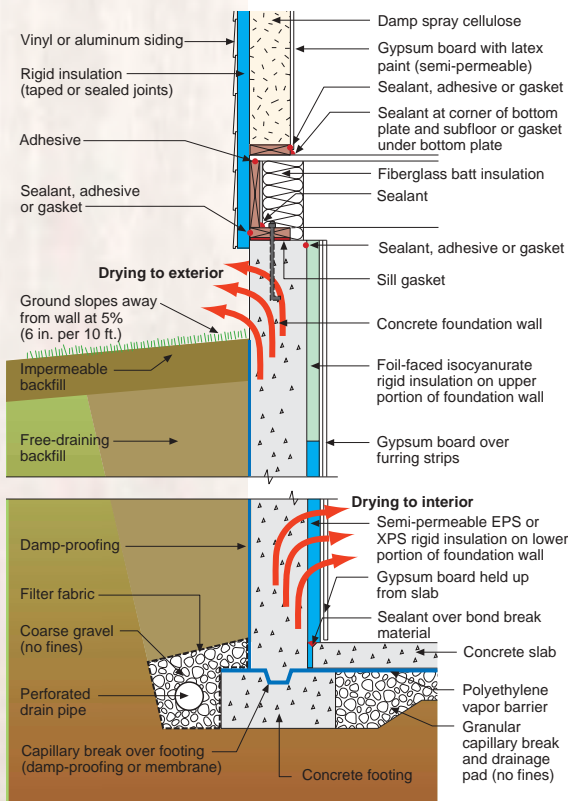

**Figure 12**

Finishing basement at a later date

- Drying continues to the interior
- Drying to the exterior

## HALF WALL INSULATION WITH FIRE-RATED FOAM SHEATHING

The fastest and most cost effective way to provide insulation is covering the upper half of the foundation wall with foil-faced polyisocyanurate foam sheathing that is fire rated for exposed use (Figure 11). This will eliminate the greatest source of heat transfer through the foundation wall while still allowing the lower half of the wall to dry to the interior. The joints between pieces of foam sheathing must be sealed using foil tape to prevent air leakage that could result in condensation on the cold foundation wall.

If at a later date the wall is to be finished, expanded polystyrene (EPS) can be used to cover the lower half of the wall (Figure 12). Expanded polystyrene is semi-permeable to water vapor and will allow the lower portion of the wall to continue to dry inwards. However, the expanded polystyrene will require thermal protection with 0.5 inch of gypsum board or equivalent.

Keeping the gypsum board off the floor a minimum of 0.5 inch will prevent wetting of the gypsum board in the event of small leak or flood. If a frame wall is placed interior to the rigid insulation, cavity insulation without a vapor barrier or retarder can be installed between the studs.

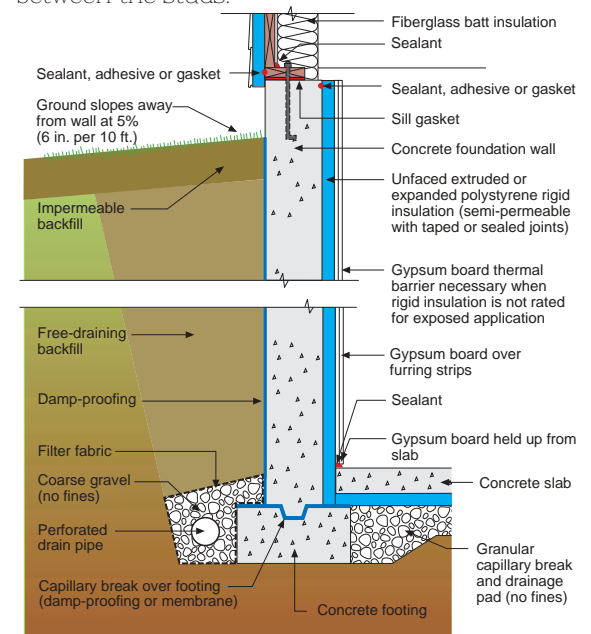

**Figure 13**

Full height basement insulation

- Upper and lower portion of wall can dry to interior

# FULL WALL INSULATION WITH FOAM SHEATHING COVERED WITH GYPSUM BOARD

Either expanded or extruded polystyrene insulating sheathing can be attached directly to the foundation wall. Since extruded polystyrene is more moisture tolerant it should be used if there is any question about the effectiveness of the external drainage system (Figure 13).

If additional insulation is desired, cavity insulation can be installed in a frame wall built interior to the foam insulation and covered with 0.5 inch gypsum board or other thermal barrier (Figure 14, Photograph 8 and Photograph 9). If no additional insulation is desired, furring strips can be attached to the wall through the foam insulation and gypsum board attached to the furring strips.

Extruded polystyrene should also be used if an internal drainage system with an interior drain is installed as shown in Figure 15. All joints between pieces of foam insulation should be sealed with mesh tape and mastic to prevent air leakage that would permit warm moist air to condense on the cold foundation wall. This approach has proven to be effective as a retrofit strategy.

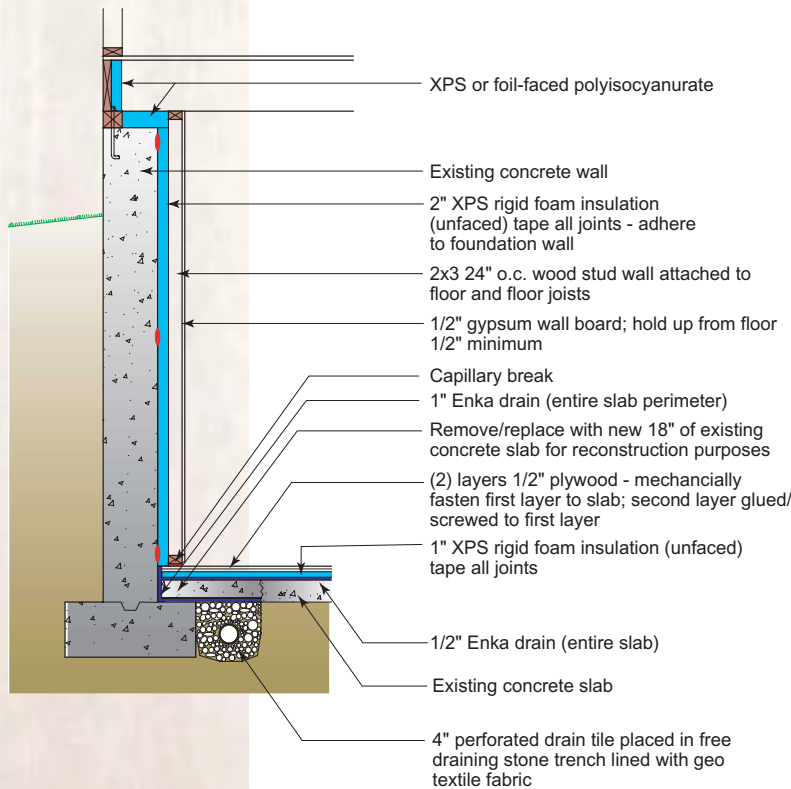

**Figure 15**  
Basement insulation with subfloor drainage

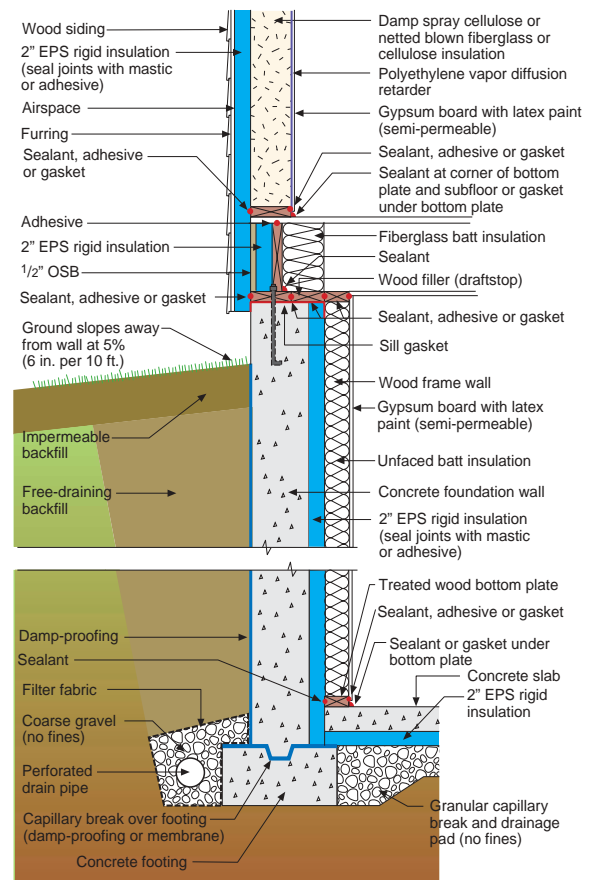

**Figure 14**  
Additional interior basement insulation



**Photograph 8**  
Unfaced extruded polystyrene against basement wall



**Photograph 9**  
Unfaced extruded polystyrene against basement wall

## PRE-CAST CONCRETE FOUNDATION WALLS

There are several proprietary insulated pre-cast concrete wall systems for basements. One such system was developed by one of our **Building America** partners, Pulte Home Corporation (**Photograph 10**). These walls generally have built in “**footers**” that rest on an engineered gravel footing that allows the entire wall including footer to be drained. As long as the joints between panels are effectively sealed these walls are warm and dry. These walls are usually constructed using concrete with a low water to cement ratio that permits the wall to be removed from the form in 12 hours or less. Because the concrete starts with less water, the walls have less water that will dry out after installation. This system is designed to be insulated with full height exterior insulation.



**Photograph 10**  
Pre-cast basement walls

Another pre-cast foundation wall system is manufactured by Superior Walls of America. These wall panels have 1-inch of Dow Styrofoam between the outer wall and the reinforced concrete studs



**Photograph 11**  
Pre-cast basement walls with XPS foam insulation

Wood nailers (0.75 inch by 2.25 inch) are cast into every concrete stud so that gypsum board or paneling is easy to attach. Additional insulation can be installed in the stud bays if needed. Superior Walls were used to **build seven Habitat for Humanity** houses in **Pontiac, Michigan**. **Building Science Corporation** provided the design for this project.

## CURRENT BASEMENT INSULATION METHODS UTILIZED BY BUILDING AMERICA BUILDERS

We have surveyed our **Building America** partners to determine how they are currently insulating basements. The majority of them (see **Table 1**) are using fiberglass batts in frame walls or vinyl faced fiberglass blankets covering either the upper half or all of the basement walls. Because the fiberglass blankets are not attached to the foundation wall in an air tight manner, air circulation between the fiberglass insulation and the wall reduces the thermal efficiency. In some circumstances this air circulation removes moisture that would otherwise be trapped behind the vinyl facing – and in other circumstances this air circulation deposits moisture at the foundation wall/insulation interface. In our experience this approach is very risky and has led to mold growth.

In Minnesota the energy code requires a moisture barrier between the foundation wall and the insulation and a vapor barrier between the insulation and the interior. As a result there is an impermeable covering on both sides of the fiberglass insulation. In the typical installation polyethylene sheeting (**moisture barrier**) is attached to the edge of the sill plate and drapes over the foundation wall onto the floor. A wood stud frame wall is built against moisture barrier; fiberglass batts are placed in the wall cavities; polyethylene sheeting is attached to

the interior side of the frame wall and 0.5 inch gypsum board is attached over the polyethylene. Electrical wires and receptacle boxes are placed within the cavities of the frame wall.

In practice the polyethylene sheeting has penetrations that permit air leakage into the cavity. At certain times of the year the warm moist interior air will condense on the colder polyethylene moisture barrier against the foundation wall. This trapped moisture permits fungal growth leading to failure of the wall within periods as short as one year. Additionally, the interior polyethylene prevents the wall assembly from drying to the interior and leads to the problems previously described in **Figures 4, 5, 6, 7** and **8**.

The one **Building America** partner who is now using exterior basement insulation made this change because of concerns that the double vapor barrier wall required by the Minnesota Energy Code for internally insulated basements would lead to moisture and mold problems.

**Table 1**

Basement Insulation Techniques Used by Building America Partners

Type of Insulation	Exterior*	Interior Foam	Insulated Pre-cast	Interior Fiberglass†
<b>Number of Builders</b>	<b>1</b>	<b>3</b>	<b>1</b>	<b>3</b>
<b>Number of Houses</b>	<b>93</b>	<b>3</b>	<b>7</b>	<b>1,143</b>

\* Exterior - rigid fiberglass (proprietary system)

† Interior fiberglass includes fiberglass blanket attached to nailers and fiberglass batts in wood frame walls.

## COST COMPARISONS

**Table 2** contains cost comparisons of seven different basement insulation approaches for both externally and internally insulated basements. What is striking is that there is a difference of approximately **\$180** between an acceptable method of providing half insulation and a method that does not work (Approach 1 vs Approach 2).

The cost goes up substantially when comparing the least expensive full height insulation (Approach 3) and the least expensive full height insulation approach that actually works (Approach 6). The difference is about **\$580**. A better comparison would be between Approach 5 (which does not work) and Approach 6 (which does work). Both are internally

insulated stud walls, but the one that works costs about **\$280** more.

Of all of the approaches, exterior insulation remains the most expensive (Approach 7).

It costs anywhere from \$180 to \$280 to \$580 more to do it correctly. The most common cost difference is the latter – approximately \$580 – hence the builder resistance. However, fear of mold litigation is beginning to have an impact on the options and the relative value of cost vs. risk.

**Table 2**  
Table of Costs

Approach number	Description	Material cost	Labor cost	Total cost		
1	1" half-height foil-faced polyisocyanurate; R-7	\$0.40/ft <sup>2</sup> \$224	2 hrs. @ \$50/hr \$100	\$324	See Figure 11	Acceptable
2	Half-height blanket insulation; R-8	\$0.25/ft <sup>2</sup>	installed	\$140	See Photo 4	Not acceptable
3	Full height blanket insulation; R-8	\$0.25/ft <sup>2</sup>	installed	\$280	See Photo 3	Not acceptable
4	2" full height EPS covered with 1/2" gypsum board; R-8	EPS \$0.50/ft <sup>2</sup> Gypsum \$0.50/ft <sup>2</sup>	installed installed	\$1,120	See Figure 13	Acceptable
5	Full height stud wall; poly; no gypsum board; unfaced fiberglass batt; R-11	Studs and insulation \$0.50/ft <sup>2</sup>	installed	\$560	See Photo 2	Not acceptable
6	Full height stud wall; no poly; no gypsum board installed (i.e. unfinished); unfaced fiberglass batt; 1" EPS; R-15	Studs and insulation (Modified Approach 5 + EPS)	installed	\$560 + \$280 = \$840	See Figure 14	Acceptable
7	2" XPS exterior insulation; R-10	XPS \$0.65/ft <sup>2</sup> Protection \$3/lin. ft.	\$728 \$420	\$1,148	See Figure 10	Acceptable

**Assumptions** 30' x 40' basement  
140 ft. perimeter  
1,120 ft<sup>2</sup> of perimeter surface area

## FIRE TESTING

It is obvious from the moisture dynamics that semi-permeable foam insulation has many attractive features. However, it has one major problem – fire spread and smoke developed characteristics that require it to be covered with a 15 minute thermal barrier.

The **Building Science Consortium** had high hopes for a hybrid wall approach that would couple the best characteristics of two approaches – interior blanket insulation and expanded polystyrene rigid insulation. The proposed approach is presented in **Figure 16**. Unfortunately, this approach failed when fire tested. Less than half of the 15 minutes of resistance required was provided by the blanket insulation.

A cellulose hybrid wall was also proposed (**Figure 17**), that will likely meet the fire requirements, but has not been tested to date.

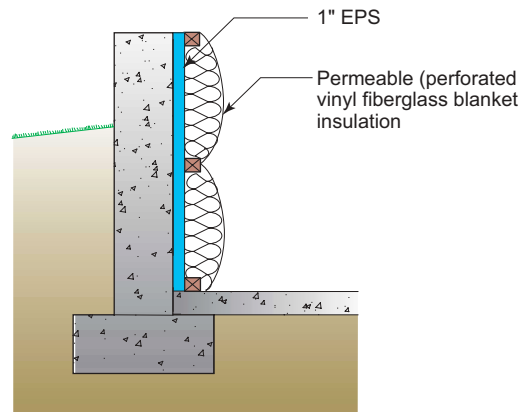

**Figure 16**  
Foam/blanket hybrid

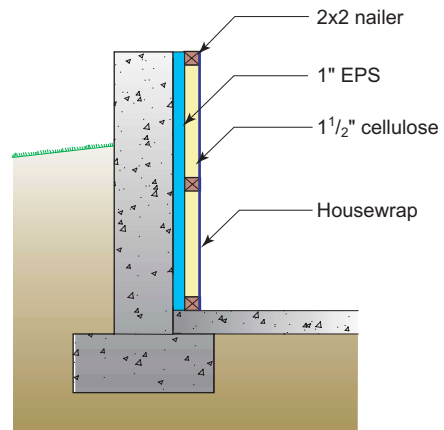

**Figure 17**  
Foam/cellulose hybrid

## WHERE WE ARE AND WHERE WE'RE GOING

Despite the efforts of the **Building Science Consortium** to develop methods to effectively insulate basements with lower risk for moisture and mold problems, most builders continue to install insulation that is thermally inefficient and prone to develop moisture problems. The higher cost of the better systems is the primary reason given by builders for resisting change. However, the energy rating systems also help to perpetuate the current practices by equating less efficient, poorly installed batt insulation with high performing, airtight foam sheathing.

The **Building Science Consortium** will continue to strongly recommend that builders adopt one of the strategies that allow drying of internally insulated basements.

## ACKNOWLEDGMENTS

This work was supported by the U.S. Department of Energy, Office of Building Technologies, State and Community Programs, Building America Program, George James, Program Manager.

## REFERENCES

- Cheple, M., and P.H. Huelman, 2001. *Why We Need to Know More About Basement Moisture*. Buildings VIII.
- CMHC, 1992. *Investigating, Diagnosing and Treating Your Damp Basement*. Ottawa, Ontario, Canada Mortgage and Housing Corporation.
- Ellringer, P., May/June 2002. *Minnesota Mold Busting*, Home Energy Magazine.
- Forest, T.W., and M.Y. Ackerman, 1999. *Basement Walls That Dry*. Ottawa, Ontario: Canada Mortgage and Housing Corporation.
- Fugler, D., March/April 2002. *Dry Notes from the Underground*, Home Energy Magazine.
- Goldberg, L.F., 1999. *Building Foundations Research Program* (<http://buildingfoundation.umn.edu>), University of Minnesota.
- Goldberg, L.F., and P.H. Huelman, 2000. *Residential research facility: Rim joist report and foundation insulation project final report*. Minnesota Department of Commerce, University of Minnesota (<http://www.buildingfoundation.umn.edu/RimJoist/recommendations.htm>)
- Jeong, J., 2001. *Simplified Hygrothermal Analysis for Building Enclosure Design*. M.A. Sci., Thesis, Civil Engineering Dept, University of Waterloo, Waterloo, Canada.
- Kesik, T.J., M.C. Swinton, M.T. Bomberg, M.K. Kumaran, W. Maref, and N. Normadin, 2001. *Cost Effective Basement Wall Drainage Alternatives Employing Exterior Insulation Basement Systems (EIBS)*. IRC/NRCC. Presented at the Eighth Conference on Building Science and Technology, Feb. 22-23, 2001, Toronto, Ontario.
- Lstiburek, J., 2001. *Builder's Guide Cold Climates*, Building Science Corp., Westford, MA.
- Lstiburek, J., 2000. *Builder's Guide Hot-Dry & Mixed-Dry Climates*, Building Science Corp., Westford, MA.
- Lstiburek, J., 2001. *Builder's Guide Mixed-Humid Climates*, Building Science Corp., Westford, MA.
- Timusk, J., 1981. *Insulation Retrofit of Masonry Basements*. Department of Civil Engineering, University of Toronto, Toronto, Canada.